

MODELLING OF ARTIFICIAL NEURAL NETWORK CONTROLLER FOR ELECTRIC DRIVE WITH LINEAR TORQUE LOAD FUNCTION

Janis Greivulis, Anatoly Levchenkoy, Mikhail Gorobetz

Riga Technical University, Faculty of Electrical and Power Engineering,
Institute of Industrial Electronics and Electrical Engineering
greivulis@eef.rtu.lv, levas@latnet.lv, mgorobetz@latnet.lv

Abstract. The purpose of this research is to model usage of neural network for speed control of DC drive in virtual laboratory. The paper is based on authors' previous scientific work researching the intelligent electronic devices for public electric transport, which use methods of the artificial intelligence and may communicate in global network with other intelligent devices. In this paper authors presents modeling of neural network controller to control speed of DC drive. DC drives are widely used in public electric transport, such as trams, trolleybuses and electric trains. The feed-forward backpropagation neural network is used for controller. Levenberg-Marquardt backpropagation algorithm is proposed as a training method. Neural network is trained to maintain speed of DC drive in defined interval. Results of modelling show the possibility to use neural network controller for speed control of DC drive.

Key words: feed-forward back-propagation neural network, DC drive, modelling.

Introduction

The paper is based on authors' previous scientific work researching the intelligent agent systems and its' application in mechatronic systems. Intelligent agents are electronic devices, which use methods of the artificial intelligence [1] and may communicate in global network with other intelligent devices.

In this paper authors presents modeling of neural network controller to control speed of DC drive. DC drives are mostly used in public electric transport systems, such as trams, trolleybuses and electric trains.

Modeling of such system control in virtual laboratory give possibility to avoid creating of real physical model replacing it by virtual model of DC drive and neural network controller with all properties of real electrical object.

Models are created and tested in virtual environment of Simulink 6.3.

Problem formulation

The purpose of this research is to use artificial neural network for speed control of DC drive in virtual laboratory.

Main tasks of research are:

- model development of DC drive;
- model development of feed-forward artificial neural network controller;
- artificial neural network training for speed control;
- modelling of neural network for speed control of DC drive in virtual laboratory.

The neural network controller should be trained to maintain speed of DC drive in defined interval by switching on engine when speed is low and switch off, when speed is too high.

Method of solution

Intelligent agents [2] for control system of a DC drive, based on neural network give possibility to analyze input data to send appropriate control signal without human intervention.

Neural Networks

Clustering analysis is based on artificial neural network model. Neural network mathematical model is based on perceptron structure. Each neuron is a perceptron with input data set, weight for each input data, activation function and output, which usually has binary value. Neural network consists of several layers. Each layer may have definite or indefinite number of neurons.

Neural networks give possibility to analyse an object by input parameter set and to detect predefined class of the object on the output. That means, neural network should be trained to detect classes and classes are predefined.

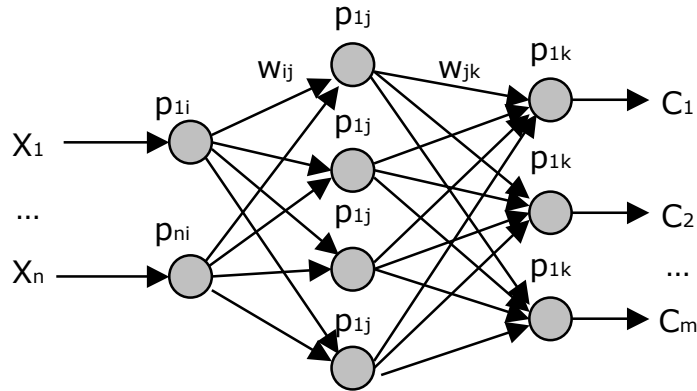

Fig. 1. Neural Network structure

Mathematical model

General Mathematical Model of Neural Network [3]

Input data set for neural network: $X = \{x_1, x_2, \dots, x_n\}$

Set of neural network hidden layers: $L = \{l_1, l_2, \dots, l_k\}$

Set of neurons for each j -th hidden layer: $P^j = \{p_1, p_2, \dots, p_r\}$

Set of neural network outputs: $C = \{c_1, c_2, \dots, c_m\}$

Weights for each input of i -th neuron of j -th layer: $W_i^j = \{w_{i1}, w_{i2}, \dots, w_{in}, w_{in}\}$

Bias for each i -th neuron of j -th layer: b_i^j

Input summation function for each i -th neuron of j -th layer: $s_i^j = \sum(W_i^j * X) + b_i^j$

Transfer function for all neurons of j -th layer: $F^j(s^j)$

Feed-forward Back-propagation Neural Network

Authors propose to use feed-forward backpropagation network for controller of DC drive.

The transfer functions F for such kind of network can be any differentiable transfer function such as:

- Hyperbolic tangent sigmoid transfer function:

$$\tanh(s) = 2 / (1 + e^{-2*s}) - 1$$

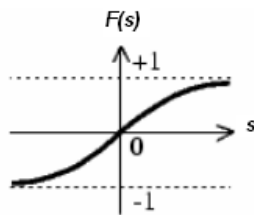

- Log sigmoid transfer function:

$$\text{logs}(s) = 1 / (1 + e^{-s})$$

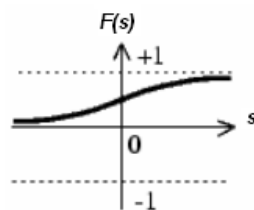

- Linear transfer function:

$$\text{lin}(s) = s$$

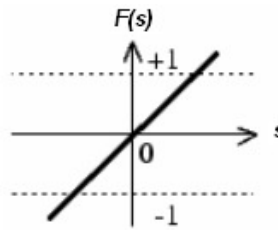

- etc.

The training function can be any of the back-prop training functions such as

- Levenberg-Marquardt backpropagation;
- Quasi-Newton backpropagation;
- resilient backpropagation;
- gradient descent backpropagation.

Algorithm for neural network controller training

Author propose to use Levenberg-Marquardt (LM) backpropagation algorithm. This network training function that updates weight and bias values according to Levenberg-Marquardt optimization.

LM usually use with:

- feed-forward network
- cascade-forward network
- Elman network etc.

LM can train any network as long as its weight, net input, and transfer functions have derivative functions.

Backpropagation is used to calculate the Jacobian jX of performance with respect to the weight and bias variables X . Each variable is adjusted according to Levenberg-Marquardt:

$$jj = jX \cdot jX, \quad (1)$$

$$je = jX \cdot E, \quad (2)$$

$$dX = -(jj+I \cdot mu) \setminus je, \quad (3)$$

where E – all errors;
 I – the identity matrix.

The adaptive value mu is increased until the change above results in a reduced performance value. The change is then made to the network and mu is decreased.

Algorithm stops when any of these conditions occur:

- The maximum number of epochs (repetitions) is reached.
- The maximum amount of time has been exceeded.
- Performance has been minimized to the goal.
- The performance gradient falls below minimum.
- Value of mu exceeds maximal value.

Computer experiment

The model of DC drive neural network speed controller is created. General schema is presented on Fig. 2.

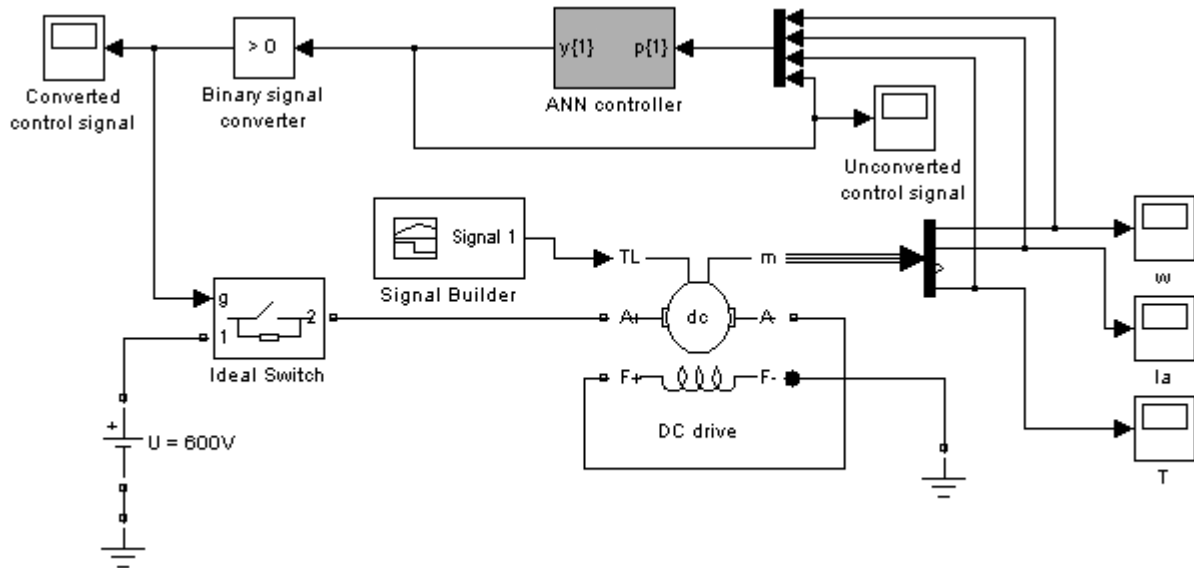

Fig. 2. Model of DC drive with ANN controller and load generator

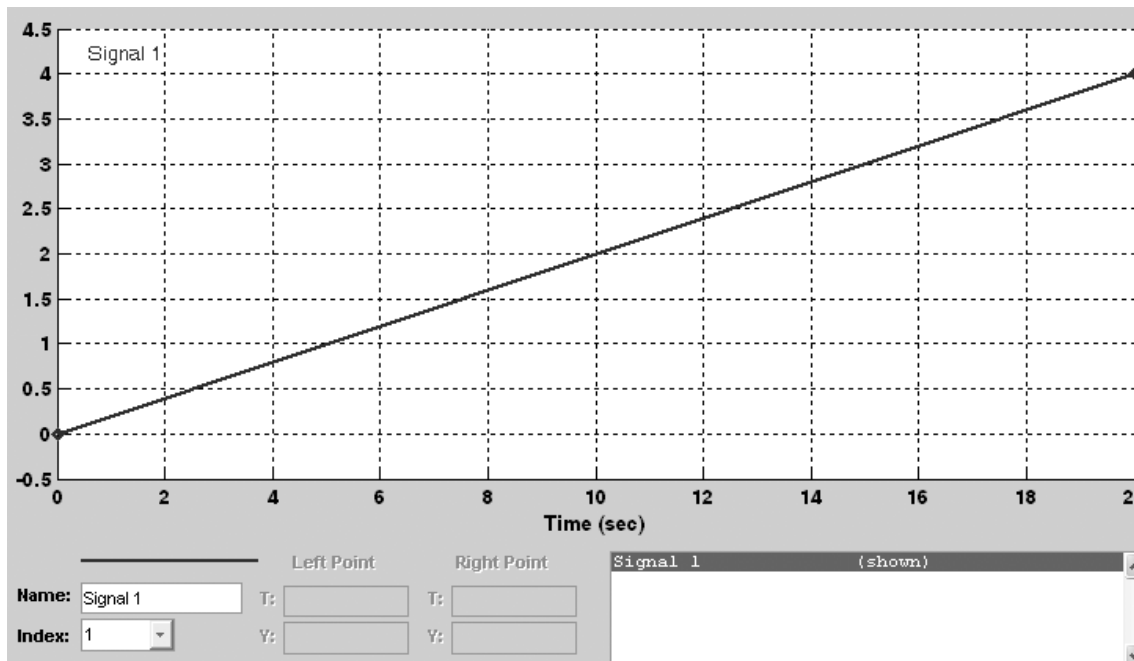

Fig. 3. Torque load with linear increment

Neural Network gets signal about rotation speed from engine sensor and also analyze own control signal, so feedback is realized.

General structure of neural network is following. Neural network consists of 1 input layer 1 hidden layer and 1 output layer (Fig. 4)



Fig. 4. Layers of neural network of controller

Each layer has set of weights and bias. Linear transfer function is used. Weighted inputs and bias are summarized (Fig. 5).

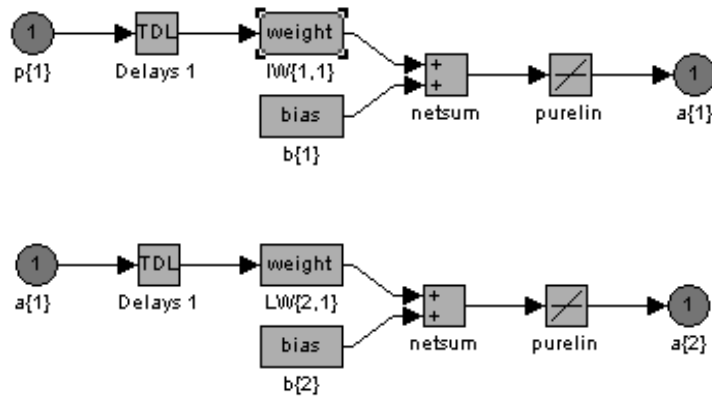

Fig. 5. Structure of neural network layers

Weights of each layer are multiplied with input signals in each neuron (Fig. 6).

Output layer (layer 2) has only one neuron (Fig. 7), because we need the only signal to control switching on a DC drive.

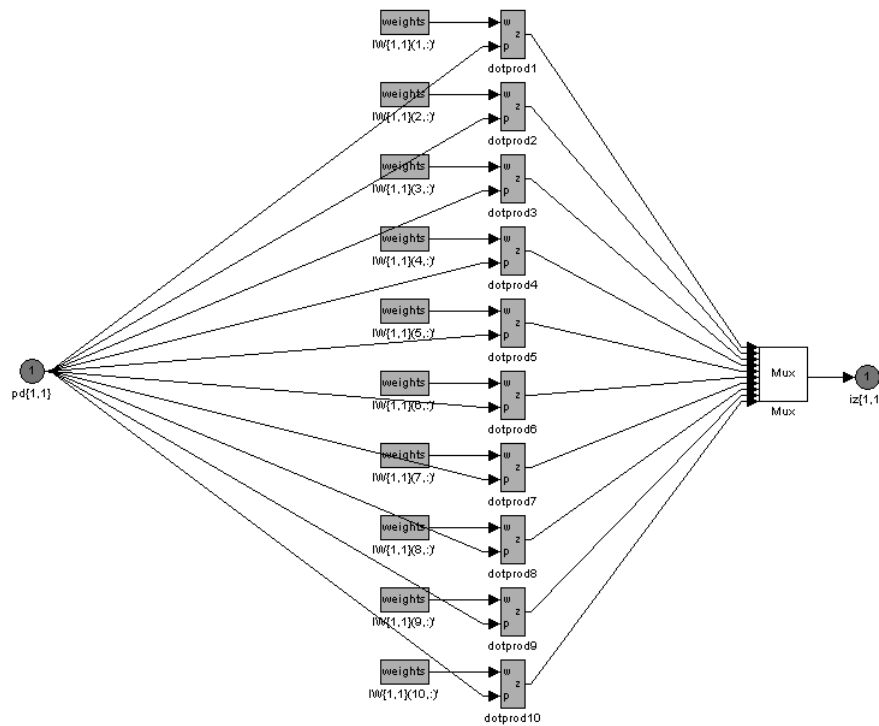

Fig. 6. Structure of hidden layer neurons

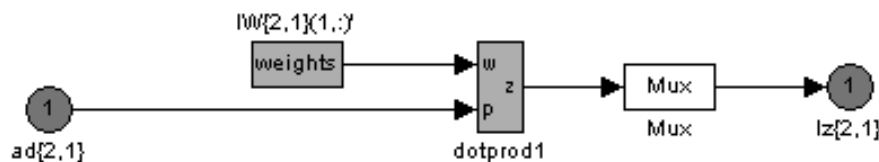

Fig. 7. Output layer neuron structure

After neural network training by Levenberg-Marquardt algorithm to maintain speed in interval between 60 rad/s and 80 rad/s [4]. These values are abstract and taken for demonstration of neural network control of DC drive.

Results of modeling are presented on Fig. 8-12.

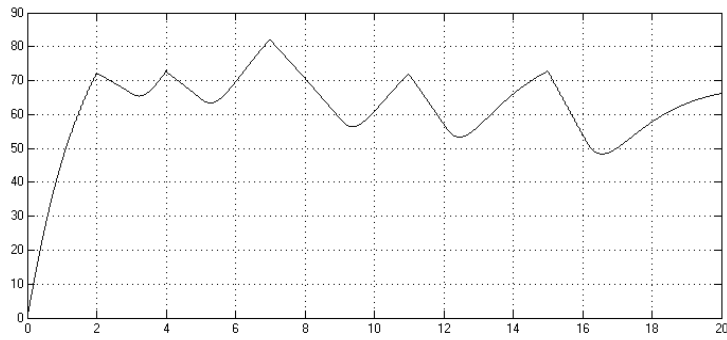

Fig. 8. Rotation speed controlled by trained neural network

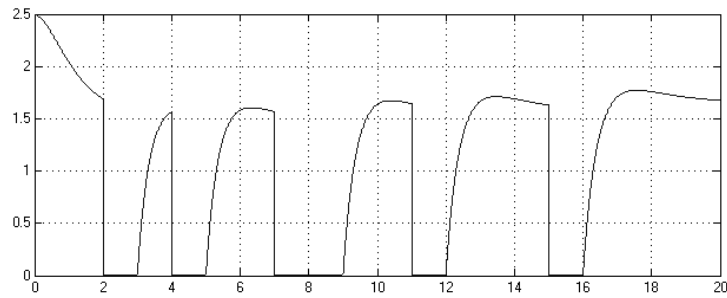

Fig. 9. Current of DC drive controlled by trained neural network

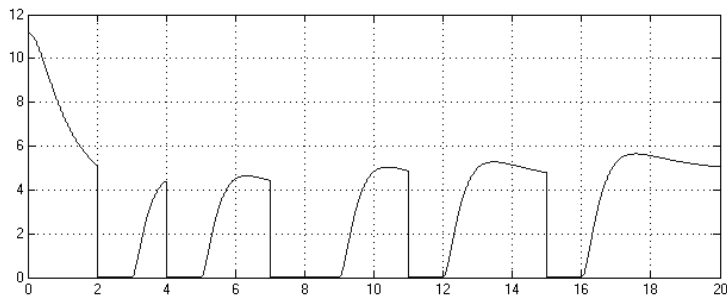

Fig. 10. Torque of DC drive controlled by trained neural network

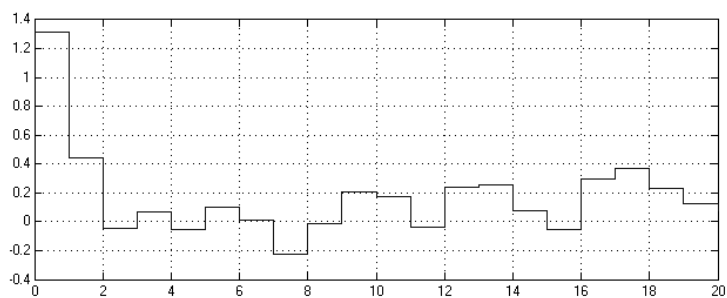

Fig. 11. Pure control signal produced by trained neural network

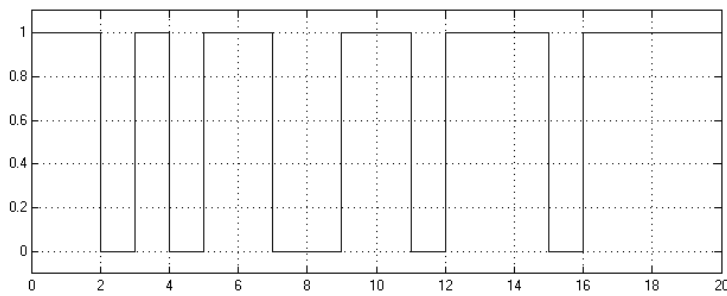

Fig. 12. Converted control signal of trained neural network

It is possible to realize neural network controller as a programmable chip.

Conclusions

Modeling results show the possibility to control speed of DC drive using trained neural network controller. It is very important to create as more as possible samples as possible for more precise training. Also selection of transfer function depends on task.

1. Neural network allows to produce not only signal but set of control signals. Also input signals are not limited.
2. Neural network controller may be used as for control as for forecasting and warning about dangerous situation.
3. It may prevent breakdowns and accidents and may be used for optimal speed control of public electric transport.

References

1. Luger G. F. Artificial Intelligence. Structures and Strategies for Complex Problem Solving, Williams, 2003, 863. p
2. S. J. Russel, P. Norvig. Artificial Intelligence. A Modern Approach, 2nd edition. Prentice Hall, 2006, 1408 p.
3. Greivulis J., Levchenkov A., Gorobetz M. Modelling of Clustering Analysis with Special Grid Function in Mechatronics Systems for Safety Tasks. //In Proceedings of 6th International Conference on Engineering for Rural Development, Jelgava, Latvia, 2007, 56-63 p.
4. Rankis I., Gorobetz M., Levchenkov A. Optimal Electric Vehicle Speed Control By Intelligent Devices. Rīgas Tehniskās universitātes raksti. Enerģētika un Elektrotehnika. Sērija 4, sējums 16. 2006. 127-137. lpp.